

Nesting. One procedure. Many possibilities.

HE HOMAG

Our CNC-Gantry Processing Center
CENTATEQ N-500

YOUR SOLUTION







Nesting: one procedure – many possibilities...

THE TYPICAL APPLICATIONS OF NESTING are creation of carcass furniture, dividing and refining of furniture fronts and construction of frame furniture.

CARCASS FURNITURE

- Routing of all components required for a carcass
- Drilling and grooving in just one cycle
- Clamping elements also provide horizontal drilling

FURNITURE FRONTS

- Fast dividing and refining of furniture fronts from one workpiece – everything in one cycle!
- The application of units provides high flexibility for the further processing

FRAME FURNITURE

- High degree of utilization due to easy handling of “free” formed parts

MORE: HOMAG.COM



CENTATEQ N-500

CONTENT

04	Highlights of the CENTATEQ N-500
06	All inclusive
08	Table field occupation
10	Options
12	intelliDivide cabinetCreator
14	Processing unit technology
16	Everything at a glance
18	Handling solutions
20	powerTouch
22	Option Process optimization
24	tapio
26	Technical data
30	Life Cycle Services



CENTATEQ N-500 – The compact nesting machine in gantry design

Our nesting machines enable cutting-optimized processing and dividing of plate-shaped materials. Various possibilities for the automation of the material handling ensure a high time saving and more effective work.

The highlights

- Gantry style – for highest precision over the total working width
- High acceleration
- Vector speed X/Y 96 m/min
- The whole working field is reachable with all processing tools
- Electronic surveillance of all stops
- Side stop guides (optional)
- 14-fold tool changing system incl. pick-up (optional)
- Optimization software (optional)
- Remaining parts handling (optional)

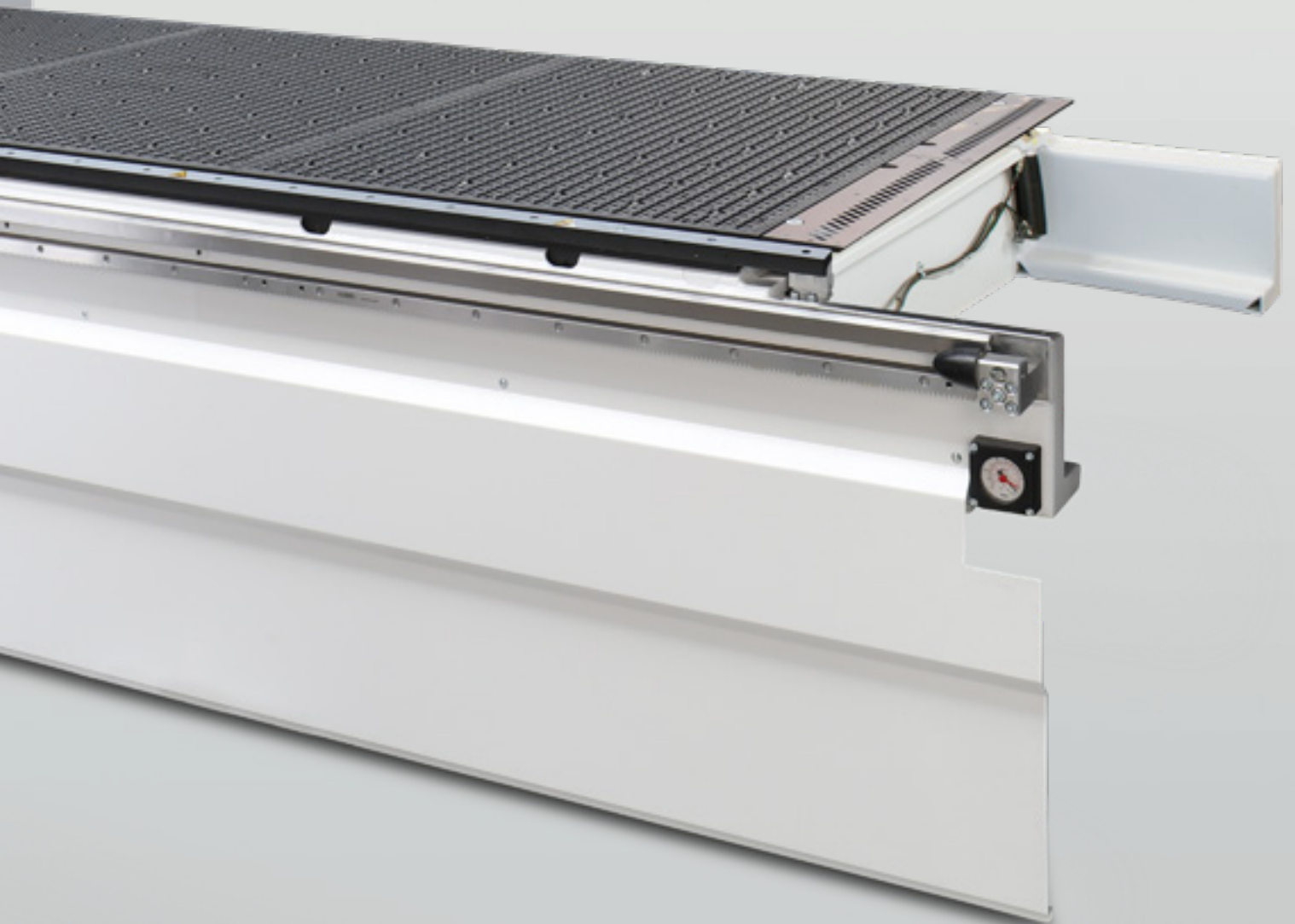

CENTATEQ N-500 – Highlights as standard

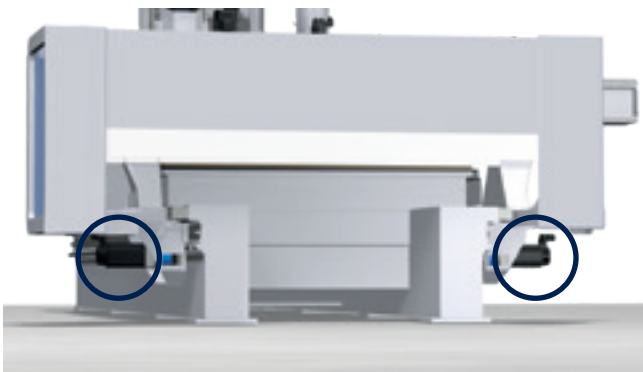

Synchronous drive

- 2 synchronized digital servo-drives in X-direction guarantee highest processing quality

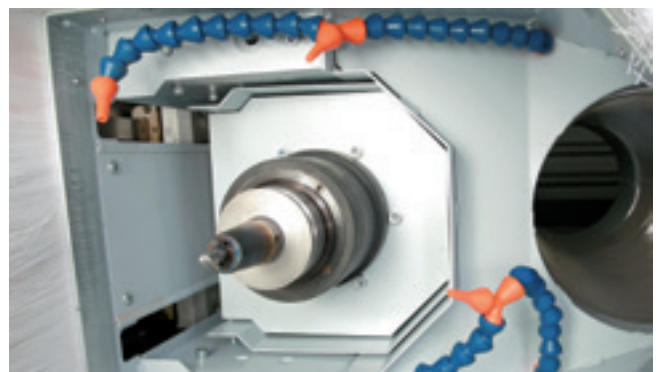

Configuration

- Standard: 13,4 HP (10 kW) HSK routing spindle
- Optional: 17,7 HP (13,2 kW) HSK routing spindle

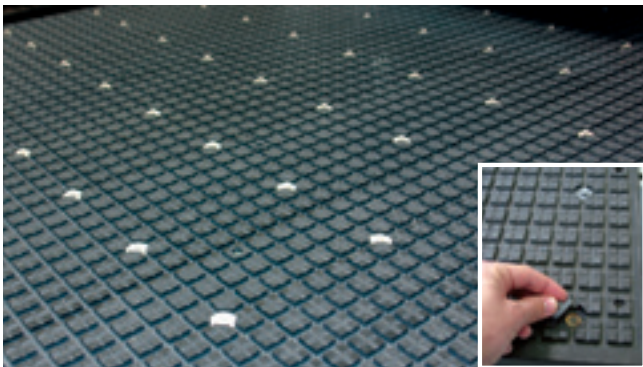

MATRIX table Pro Plus

- High flexibility
- With grid grooves for clamping of templates or workpieces. Grid grooves for inlaying of a rubber sealing.



Tool changing system

- Depending on working field in standard:
CENTATEQ N-500 / 480 = 7 places
CENTATEQ N-500 / 512 = 8 places
CENTATEQ N-500 / 612 = 10 places
CENTATEQ N-500 / 714 = 14 Plätze

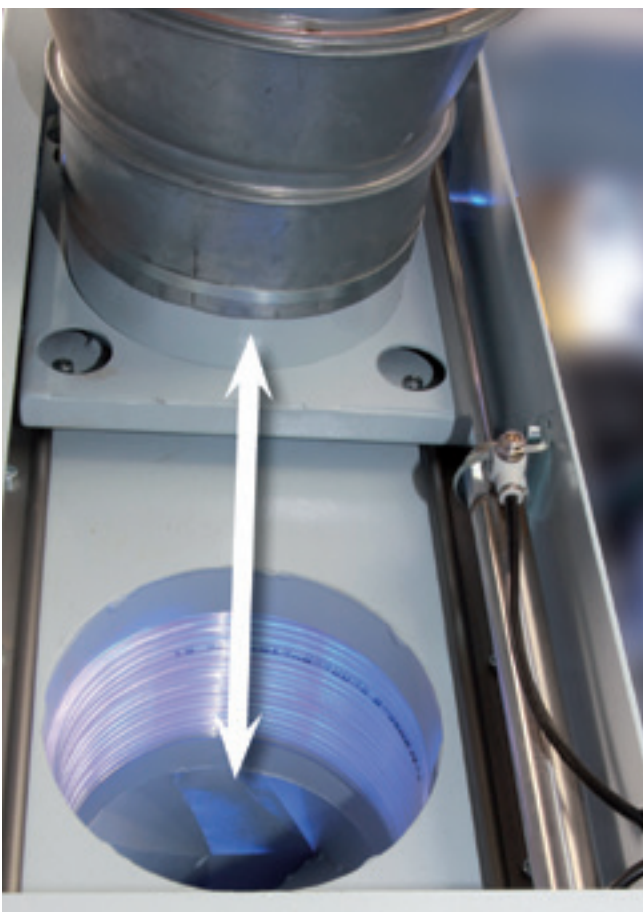
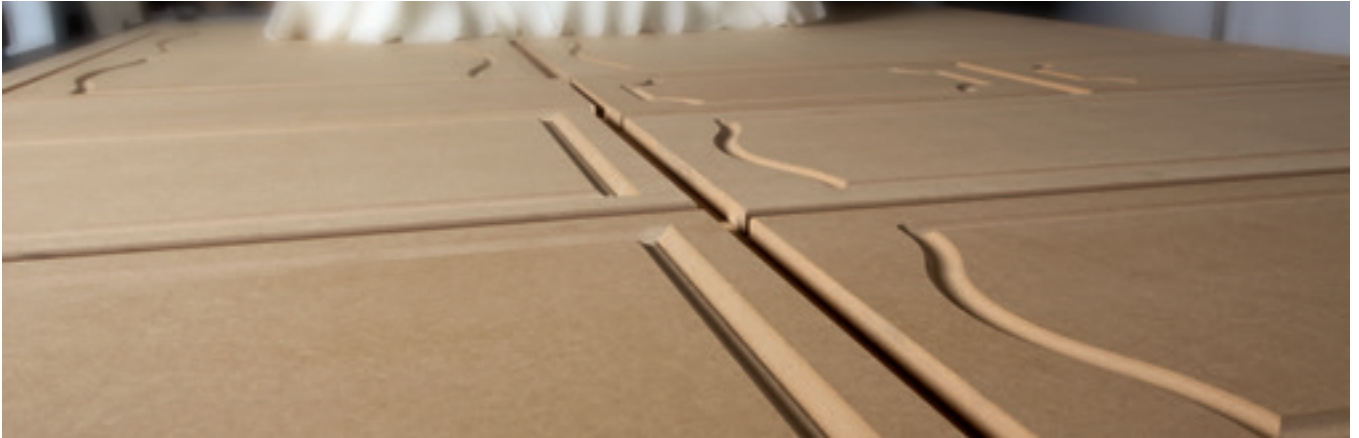

Program-controlled extraction connection

- For an optimum dust extraction and economic use of extraction energy (ecoPlus)

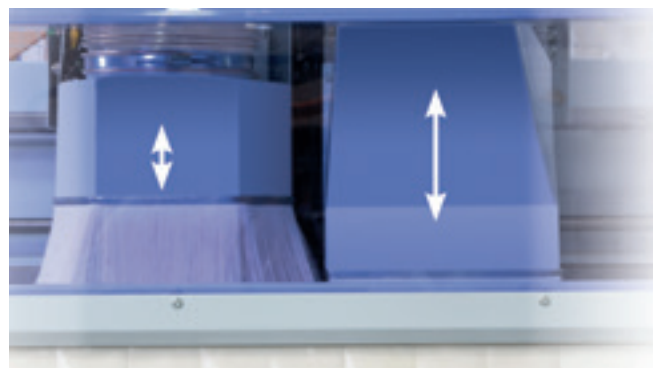

2 CNC-controlled Z-axes in combination with drilling block

- Optimal dust extraction and bigger operative range for processing units
- Weight distribution of the mass (processing units) to the two Z-axes = more stability, higher processing quality

YOUR BENEFITS:

1. Proven components for high quality standards

2. Optimal design of the tool changing places

3. Clean nesting by optimized extraction

CENTATEQ N-500 – Efficient table field occupation by MATRIX Pro Plus

By automatically selecting and deselecting the table field occupation, the vacuum is activated in the required area and is effective where it is needed. The areas are optimally matched to the established range of boards.

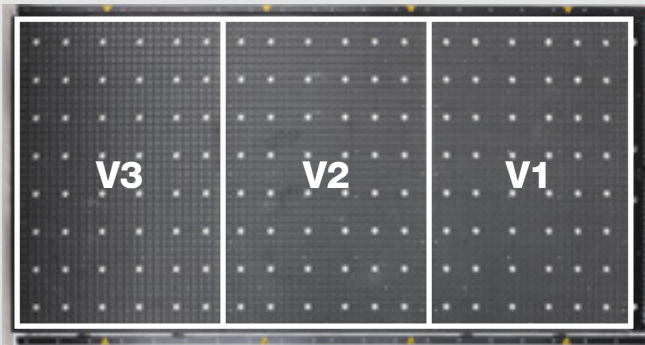

Segmentation of vacuum zones on the example of table size
1.250 x 2.520 mm | 4 x 8 ft

- Segmentation in 3 fields
- 2,6 x 4 ft
- 5,2 x 4 ft
- 8,4 x 4 ft

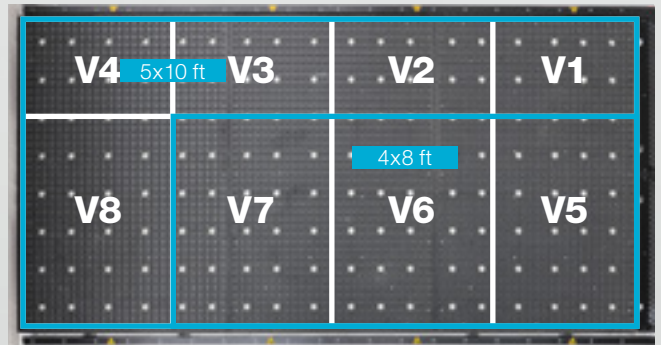

Segmentation of vacuum zones on the example of table size
1.550 x 3.100 mm | 5 x 10 ft

- Segmentation in 8 fields
- 4 x 8 ft, 4 x 10 ft
- 5 x 8 ft, 5 x 10 ft

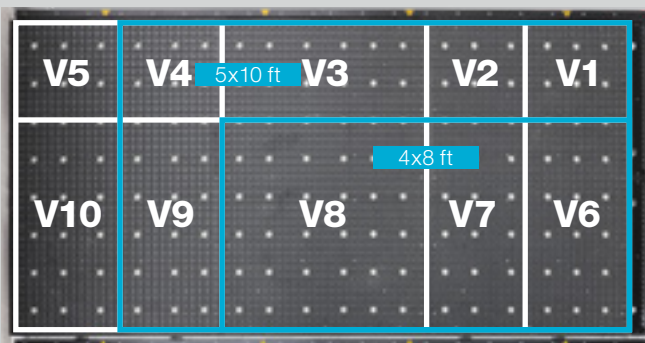

Segmentation of vacuum zones on the example of table size
1.550 x 3.700 mm | 5 x 12 ft

- Segmentation in 10 fields
- 4 x 8 ft, 4 x 10 ft, 4 x 12 ft
- 5 x 8 ft, 5 x 10 ft, 5 x 12 ft

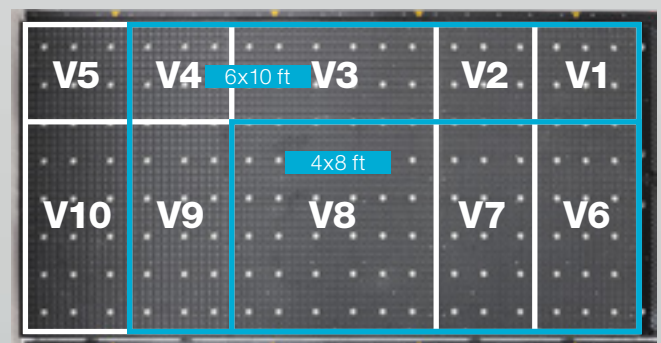

Segmentation of vacuum zones on the example of table size
1.850 x 3.700 mm | 6 x 12 ft

- Segmentation in 10 fields
- 4 x 8 ft, 4 x 10 ft, 4 x 12 ft
- 6 x 8 ft, 6 x 10 ft, 6 x 12 ft

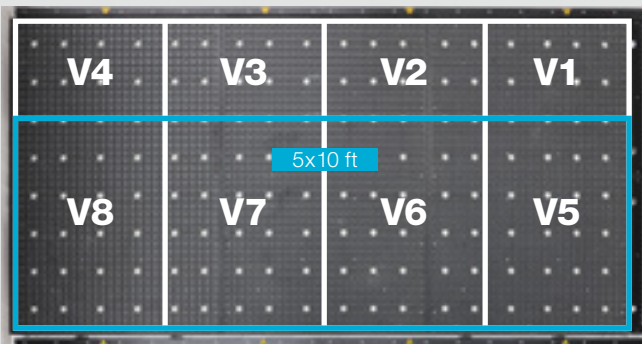

Segmentation of vacuum zones on the example of table size **2.250 x 3.100 mm | 7 x 10 ft**

- Segmentation in 8 fields
- 5 x 8 ft, 5 x 10 ft
7 x 8 ft, 7 x 10 ft

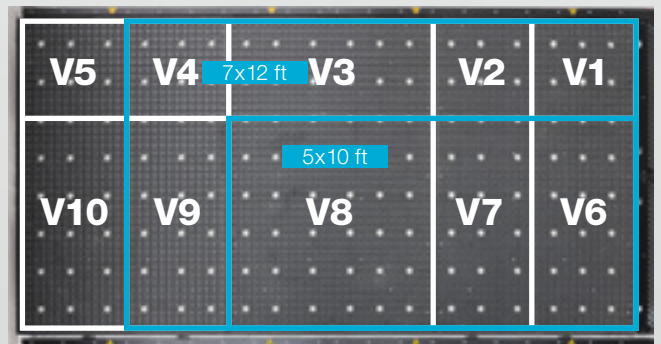

Segmentation of vacuum zones on the example of table size **2.250 x 4.300 mm | 7 x 14 ft**

- Segmentation in 10 fields
- 5 x 10 ft, 5 x 12 ft, 5 x 14 ft
7 x 10 ft, 7 x 12 ft, 7 x 14 ft

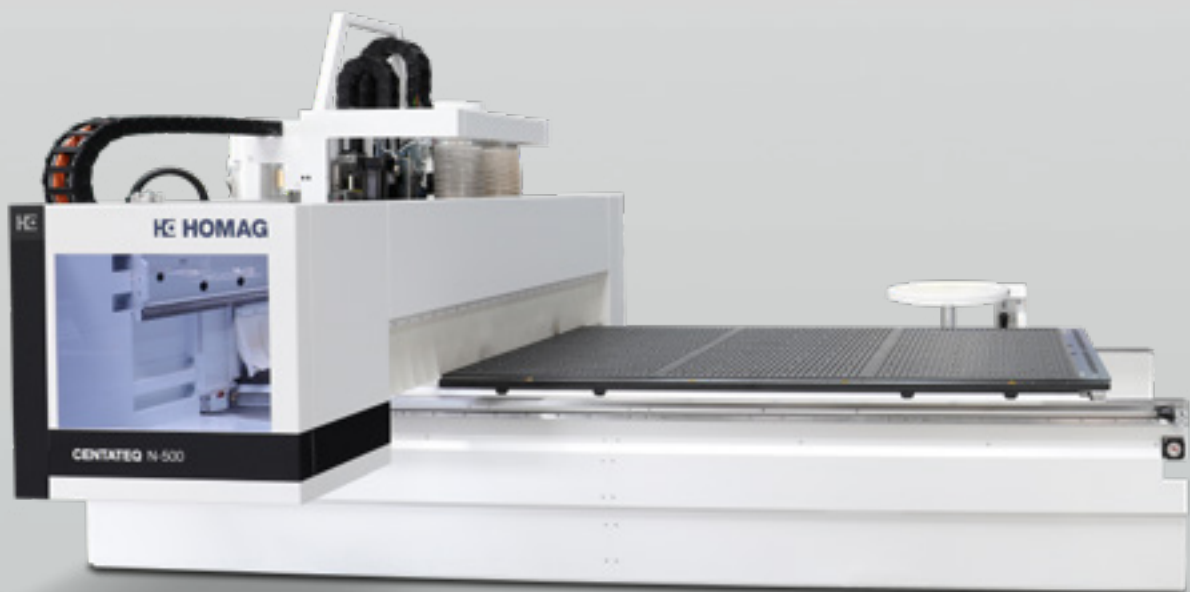



Options

WOULD YOU LIKE SOMETHING EXTRA? Our options provide all opportunities for a perfect adjustment of your nesting machine to your requirements.

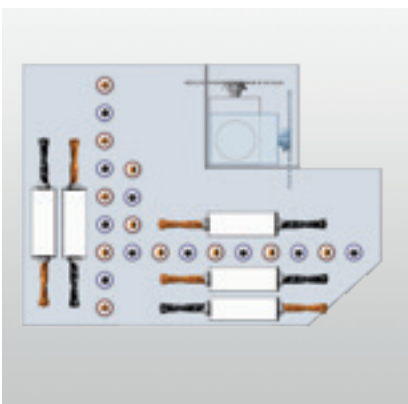

High-Speed 7500 Drilling block | 21 spindles

- 21 vertical drilling spindles
- 6 horizontal drilling spindles in X
- 4 horizontal drilling spindles in Y
- 1 grooving saw \varnothing 125 mm (0° / 90°)

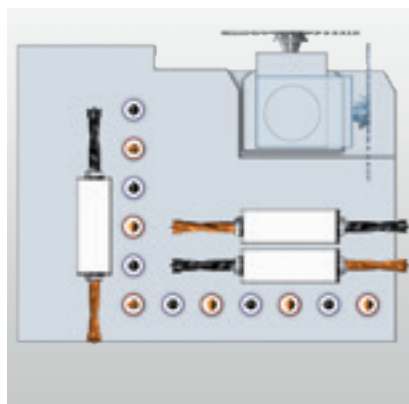

High-Speed 7500 Drilling block | 12 spindles

- 12 vertical drilling spindles
- 4 horizontal drilling spindles in X
- 2 horizontal drilling spindles in Y
- 1 grooving saw \varnothing 125 mm (0° / 90°)



High-Speed 7500

- Spindles with 1500 - 7500 RPM incl. the patented quick change system

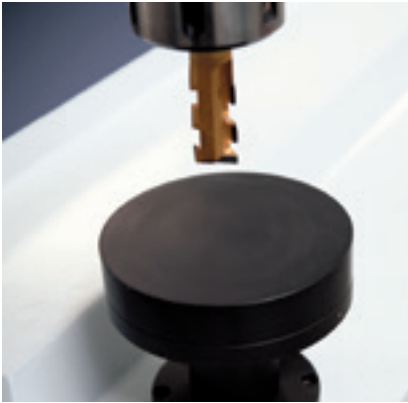

Tool length control

- Following the tool change a tool length control is carried out and compared with the integrated tool data file



Tool changer

- Tool changing system, fixed behind the machine, 14, 28 or 42 places



Tool box »STARTER KIT«

- Top equipment – from the very start

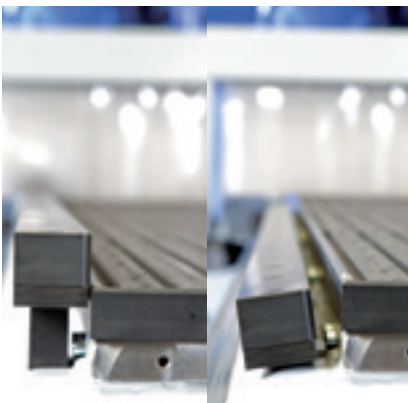

Lowerable fence guide

- Suitable for safe outfeed of workpieces



Extension stop system

- 4 pneumatically lowerable aluminium stop cylinders (in front right or in front left)



Clamping elements

- Different clamping elements available as option

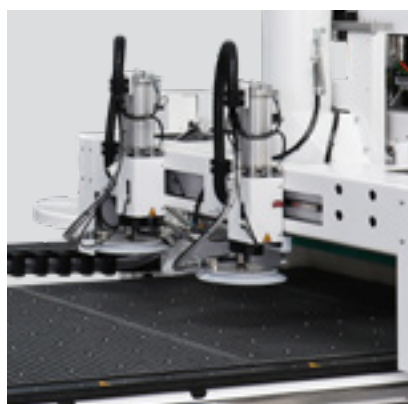

Vacuum lever for raw panel positioning

- For automatic positioning of the raw panels against the fence guide



Barcode connection

- Barcodescanner / -software
- Supported barcodes:
1D – Barcode
2D – Data Matrix Code
- Every workpiece is exactly identified for the further workpiece flow

intelliDivide nesting – cutting optimization system for CNC machines

intelliDivide is a web-based cutting optimization system from the HOMAG Group. Depending on the machine type selected, the software adapts automatically to the plate layout for each saw or to nesting with the CNC machine.

The cloud-based optimization software enables significantly higher computing capacity, ensuring that results are available quickly – and with considerably better key figures.



The benefits:

- No local hardware required. IntelliDivide works independently of the operating system — Internet access is all that is needed
- Users do not have to worry about maintenance or updates
- Low-cost introduction to optimization
- Intuitive, simple operation
- Simple, usage-based booking possible. Whether it's a free trial month, a monthly purchase or an annual subscription. Every customer is looking for what's best for them

Design furniture online and automatically receive all production data with the cabinetCreator

There are now many online stores in the industry. However, these stores tend to be operated by suppliers, from whom end customers order their furniture. With the cabinetCreator, HOMAG is offering the industry's first web-based furniture design wizard, which allows the customer to create cabinets for its end customers. The integrated scan connector adds all fixtures automatically. All relevant data is then generated so that the cabinet can be manufactured.

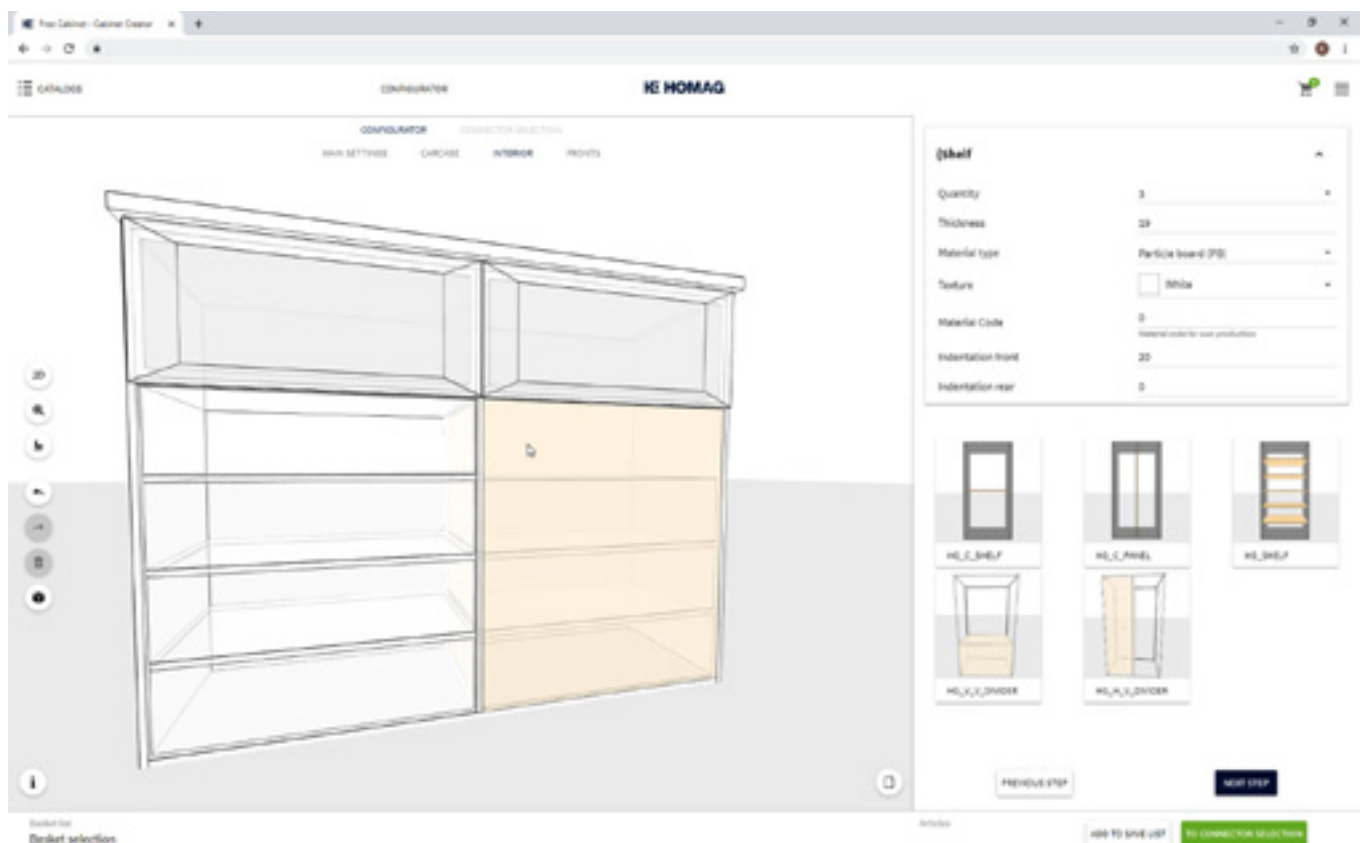

Customer benefits:

- Easy operation with step-by-step navigation
- Very fast generation of production data
- Option of setting up a custom furniture library
- Storage of individual design rules

The benefits:

- Web-based configuration of furniture bodies, so no local hardware is required
- cabinetCreator operates independently of the operating system — Internet access is all that is required
- Users do not have to worry about maintenance or updates
- Library of basic forms, e.g. straight cabinets, corner cabinets, cabinets for sloping ceilings
- Fixture selection available from all established manufacturers: Blum, Grass, Häfele, Hettich, Lamello
- 2D/3D image of the furniture
- All relevant production data generated: customer order, parts list for cutting, CNC programs, single part drawings, 3D assembly drawing



Processing unit technology

INNOVATION. PRECISION. PASSION. Over 20 years of experience in the development of units are reflected in the advanced stage of today's unit engineering. The HOMAG units are distinguished by their extreme rigidity, outstanding precision and stability.



C-axis (0-360°) for the use of units



Extension to FLEX5 consisting of FLEX5 interface and FLEX5 unit

HIGH PERFORMANCE UNITS ensure optimum lubrication of gear components for prolonged operations.

FLEX5



HIGH PERFORMANCE
Drilling/Sawing/Routing

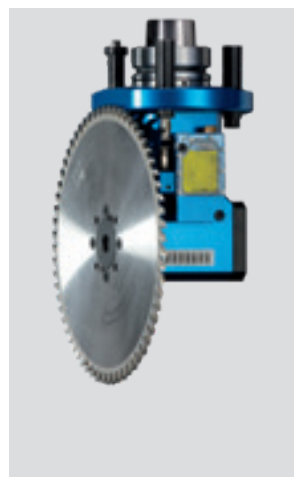

HIGH PERFORMANCE
Sawing Ø 220 mm



HIGH PERFORMANCE
Planing unit | Tool diameter max. 120 mm



Drilling/Routing/Sawing
2 spindles
(also available as HIGH PERFORMANCE unit)



Drilling/Sawing
swivelling (0° - 90°), Ø 180 mm
(also available as HIGH PERFORMANCE unit)



Routing
with 4-fold blowing nozzle



Tracing routing unit with tracing ring
Ø 70 mm | Ø 130 mm



Cutting unit
1 cutting blade | 10 mm cutting surface



Foil cutting unit
1 cutting wheel | Ø 75 mm



Drilling/Routing
swivelling cranked (0° - 90°),

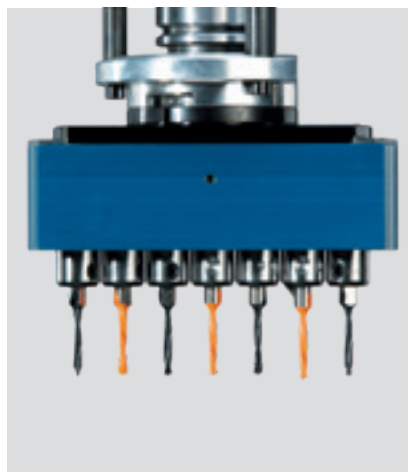

Drilling
7 spindles, 25 mm raster



Fitting drilling head
3 spindles

CENTATEQ N-500 | Everything at a glance...

With these packages you are up to all tasks. The choice is yours.

	Table sizes						Tool changing spindle				Unit interfaces			Drilling gear				Drilling gear additional			Tool changing system					
	4 x 8 ft	5 x 10 ft	5 x 12 ft	6 x 12 ft	7 x 10 ft	7 x 14 ft	10 kW air-cooled (standard)	13,2 kW air-cooled (optional)	11 kW liquid-cooled (optional)	16 kW liquid-cooled (optional)	360° adjusting axis	C-axis	C-axis for Flex5 unit	V12	V21	V12 incl. quick-change system	V21 incl. quick-change system	Horizontal drilling unit with 2 spindles in X direction	Horizontal drilling unit with 2 spindles in Y direction	Grooving saw 0°/90° swivelling	4 x 8 ft	5 x 10 ft	5 x 12 ft	6 x 12 ft	7 x 10 ft	7 x 14 ft
Basic machine	●	●	●	●	●	●	✓	○	○	○	○	○	○	○	○	○	○	○	○	○	7	8	8	10	14	14
Nesting concept outfeed	●	●	●	●	●	●	✓	○	○	○	○	○	○	○	○	○	○	○	○	○	7	8	8	10	14	14
Nesting concept 1	●	●	●	●	●	●	✓	○	○	○	○	○	○	○	○	○	○	○	○	○	7	8	8	10	14	14
Nesting concept 1R	●	●	●	●	●	●	✓	○	○	○	○	○	○	○	○	○	○	○	○	○	7	8	8	10	14	14
Nesting concept 2	●	●	●	●	●	●	✓	○	○	○	○	○	○	○	○	○	○	○	○	○	7	8	8	10	14	14
Nesting concept 3	●	●	●	●	●	●	✓	○	○	○	○	○	○	○	○	○	○	○	○	○	7	8	8	10	14	14
Nesting concept 3R	●	●	●	●	●	●	✓	○	○	○	○	○	○	○	○	○	○	○	○	○	7	8	8	10	14	14





Tool changer disk type with pick-up fixed (optional)			Automation						Equipment															
14-fold	28-fold	42-fold	Conveyor belt	Roller track	Lifting table	Infeed roller table	Barcode printer	tapio-ready	PowerControl with powerTouch	Synchronous drive	Vacuum arms for panel positioning	Push-Off device for workpieces	Extraction in the outfeed from below	Extraction in the outfeed from above	Vakuum System	SchnittProfil(t) Nesting	intelliDivide	Clamping elements	Air cushion function	Air-conditioning	Manual labeling terminal	Simultaneous pull-in and push-out		
<input type="radio"/>	<input type="radio"/>	<input type="radio"/>	-	-	-	-	-	✓	✓	✓	-	-	-	-	✓	<input type="radio"/>	<input type="radio"/>	<input type="radio"/>	<input type="radio"/>	<input type="radio"/>	<input type="radio"/>	<input type="radio"/>	-	
<input type="radio"/>	<input type="radio"/>	<input type="radio"/>	✓	-	-	-	-	✓	✓	✓	-	✓	<input type="radio"/>	<input type="radio"/>	✓	<input type="radio"/>	<input type="radio"/>	<input type="radio"/>	<input type="radio"/>	<input type="radio"/>	<input type="radio"/>	<input type="radio"/>	-	
<input type="radio"/>	<input type="radio"/>	<input type="radio"/>	✓	✓	-	-	-	✓	✓	✓	✓	✓	✓	<input type="radio"/>	✓	<input type="radio"/>	<input type="radio"/>	<input type="radio"/>	<input type="radio"/>	<input type="radio"/>	<input type="radio"/>	<input type="radio"/>	<input type="radio"/>	
<input type="radio"/>	<input type="radio"/>	<input type="radio"/>	✓	✓	-	✓	-	✓	✓	✓	✓	✓	✓	<input type="radio"/>	✓	<input type="radio"/>	<input type="radio"/>	<input type="radio"/>	<input type="radio"/>	<input type="radio"/>	<input type="radio"/>	<input type="radio"/>	<input type="radio"/>	
<input type="radio"/>	<input type="radio"/>	<input type="radio"/>	✓	✓	✓	-	-	✓	✓	✓	✓	✓	✓	<input type="radio"/>	✓	<input type="radio"/>	<input type="radio"/>	<input type="radio"/>	<input type="radio"/>	<input type="radio"/>	<input type="radio"/>	<input type="radio"/>	<input type="radio"/>	
<input type="radio"/>	<input type="radio"/>	<input type="radio"/>	✓	✓	✓	-	✓	✓	✓	✓	✓	✓	✓	<input type="radio"/>	✓	<input type="radio"/>	<input type="radio"/>	<input type="radio"/>	<input type="radio"/>	<input type="radio"/>	<input type="radio"/>	<input type="radio"/>	<input type="radio"/>	
<input type="radio"/>	<input type="radio"/>	<input type="radio"/>	✓	✓	-	✓	✓	✓	✓	✓	✓	✓	✓	<input type="radio"/>	✓	<input type="radio"/>	<input type="radio"/>	<input type="radio"/>	<input type="radio"/>	<input type="radio"/>	<input type="radio"/>	<input type="radio"/>	<input type="radio"/>	

Standard: ✓ Available: ● Option: ○

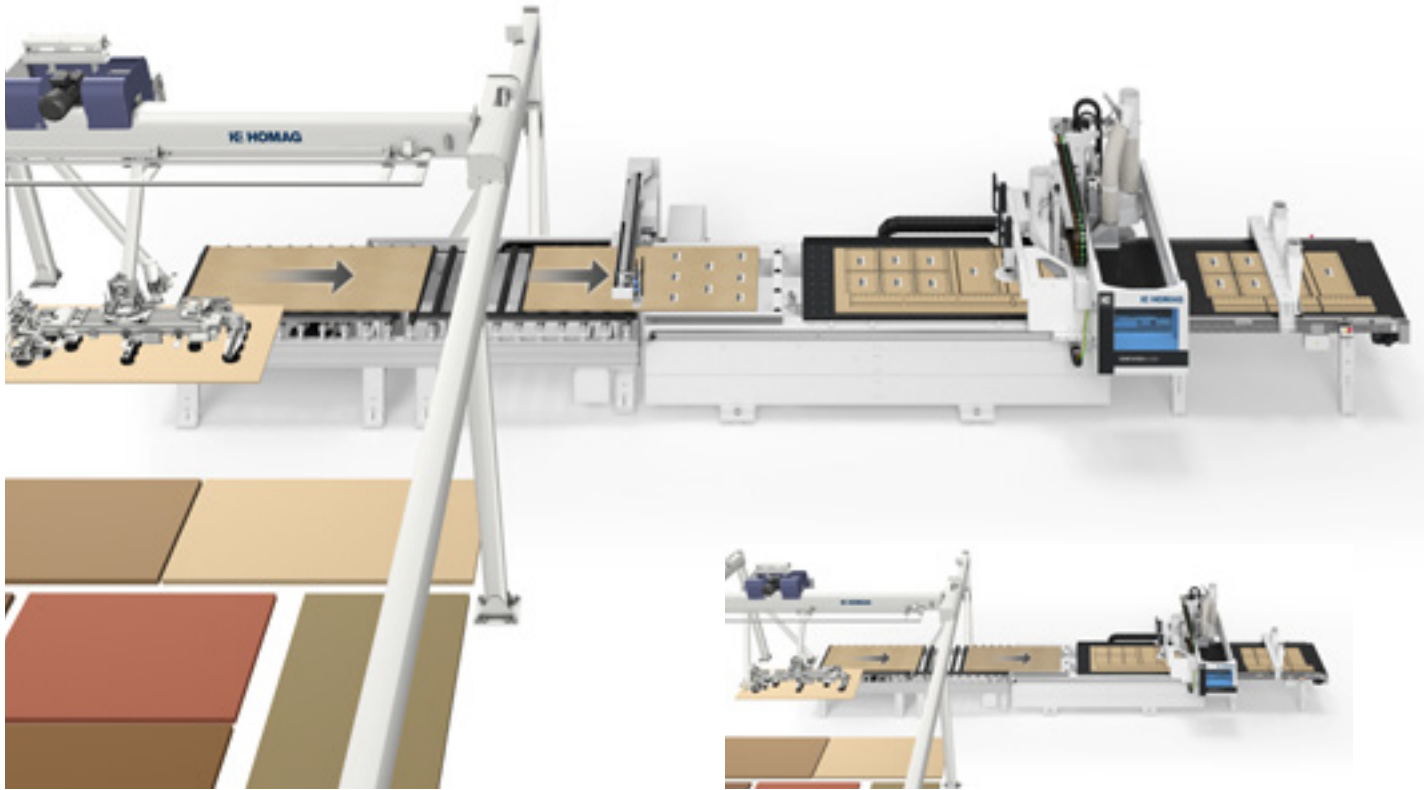

Nesting concept 3R with storage

Nesting concept 1R with storage

We have the solution for your nesting requirements!

With the HOMAG nesting solutions you are always well-advised. Whether the workpieces should be fed by hand, by lifting carriage or by storage – we have always the proper concept for your application. You wish to identify, for example, the workpiece flow exactly by barcode? No problem! With our plug & play features, we enable the successive expansion of the machine from concept 1 onwards.

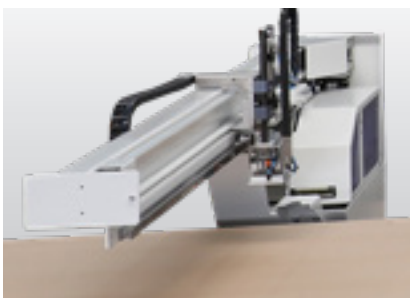

Label printing system

- Automatic labelling of raw boards before processing
- Modular concept – plug & play (retrofitable)
- Fast – 60 m/s in X-direction



Air cushion function

- Optimal and smooth feeding of workpieces for easy handling

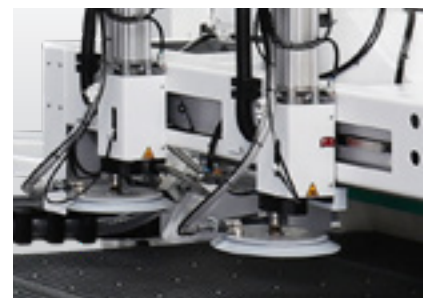

Infeed- and push-off function

- For simultaneous infeed of the raw material and push-off of processed workpieces



Basic machine



Nesting concept 1



Nesting concept 1R



Nesting concept 3R



Nesting concept 2



Nesting concept 3

Handling solutions for CENTATEQ N-500

Basic machine



Basic machine with outfeed belt



Basic machine with outfeed belt incl. preparation for external infeed



Basic machine with outfeed belt and conveyor
(available with lift table or roller table)



Basic machine with outfeed belt, conveyor and labelling system
(Lift table or roller table)



Integration in HOMAG Automation storage



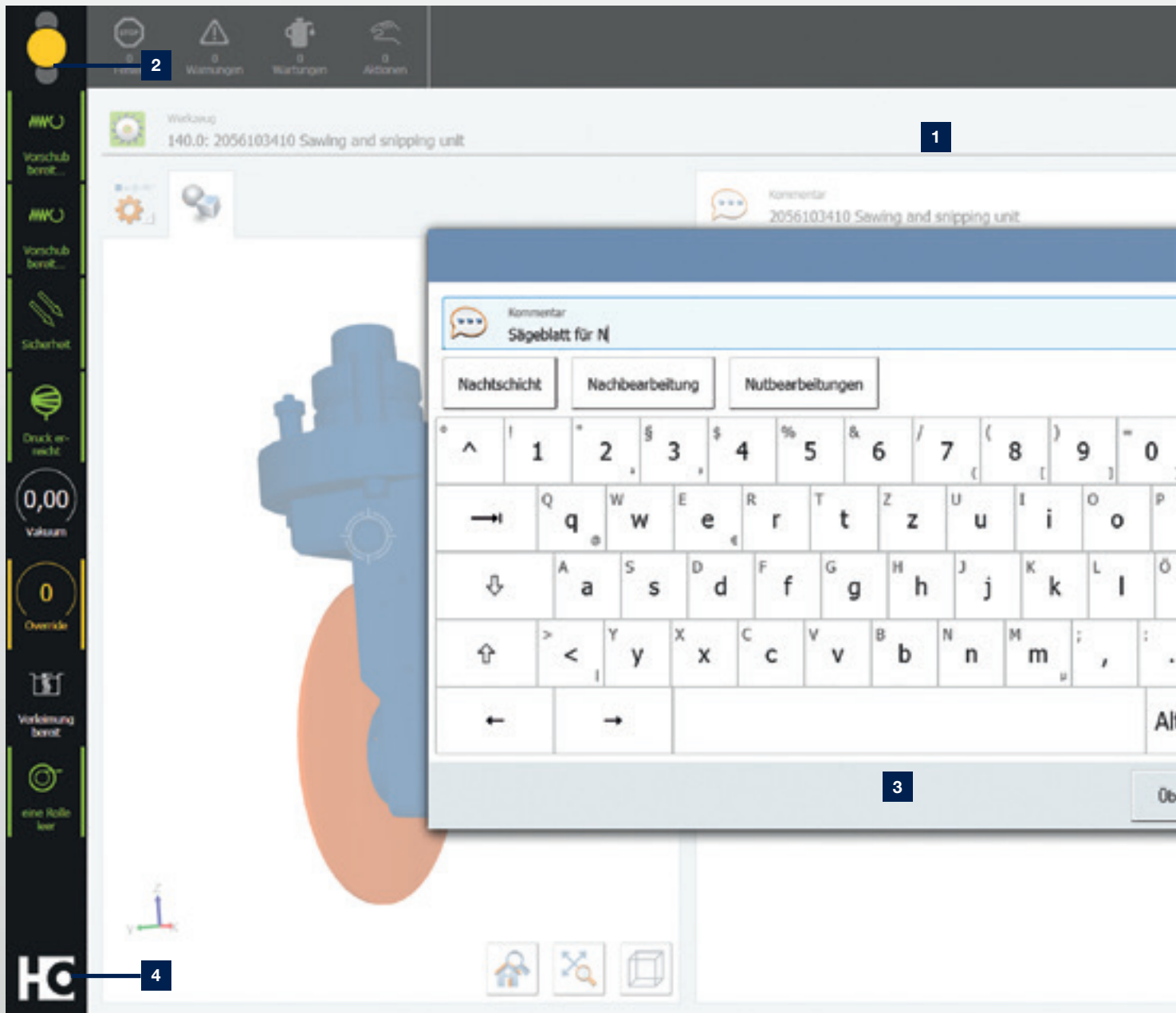

- 1 The powerTouch2 screen is clearly structured. You can see all the important information at a glance, but you still have all the details.
- 2 We have also improved the traffic light dialog further. You can now directly influence the machine's production readiness by selecting actions via the traffic light icon.
- 3 A functional pop-up keyboard that can be kept open, including automatic word completion for faster entries (when you enter the first letters, frequently used applications are proposed and you can select them directly).
- 4 Enhanced "Start" menu with additional information displayed (e.g. an indication of how many messages are currently pending or status bars that show the progress of the application) and direct access to actions (e.g. confirmation of actions without having to jump to the application).

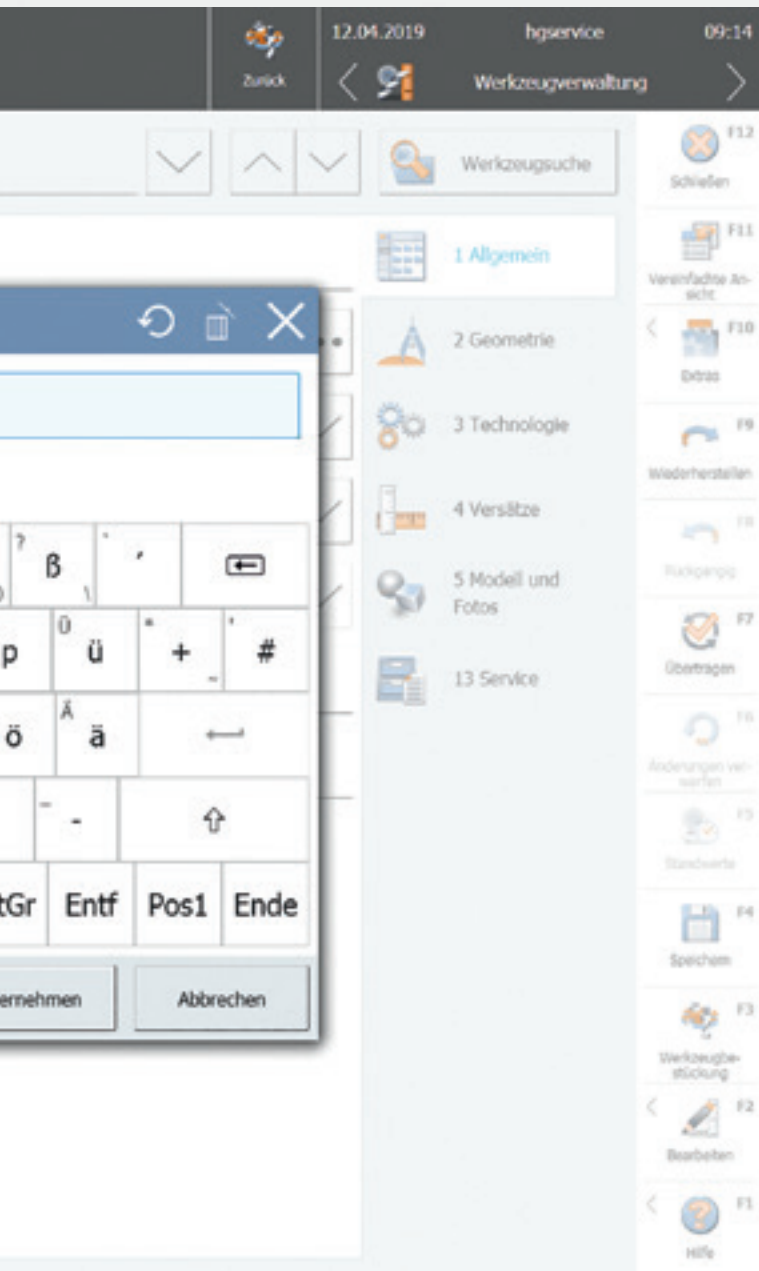

The next generation of powerTouch: **powerTouch2**

Faster, more comfortable, clearer: Enjoy the benefits of our further improved powerTouch user interface. We have optimized our standardized operating concept and further adapted it to our customers' requirements. Controlling your HOMAG machines is now even faster and more intuitive. The new, modern design has a clear structure. The innovative touch operation allows you to achieve the desired result easily and comfortably.

With the new powerTouch generation, you can enter information at your machine even more quickly. Compared to the previous version, you can achieve a time saving of up to 30%. This is possible thanks to new features, such as automatic word completion, a pop-up keyboard that can be kept open and Windows-like functions, such as the selection of common actions directly via the start button.

Our successful powerTouch philosophy – **standardized, simple, ergonomic, evolutionary** – consistently further developed



THE HIGHLIGHTS AT A GLANCE:

- Direct and efficient operation, up to 30% faster
- Clearer and more informative thanks to additional information and live illustrations instead of program icons
- New applications for operating and controlling machines and systems (e.g. NCCenter in the PC87 control system on CNC machines or woodCommander 4 on throughfeed machines)
- Fresh, attractive design, based on the new HOMAG machine design

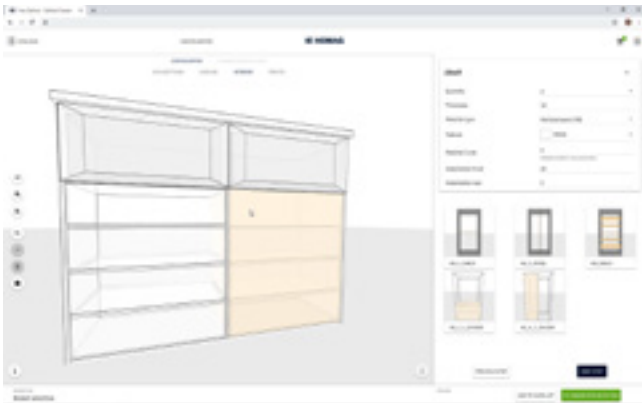

cabinetCreator

- Design furniture online and automatically receive all production data

Software | Machine

Our machines are equipped with everything needed for productive use as standard. In addition, a wide range of software modules can be supplemented to create the optimum configuration.

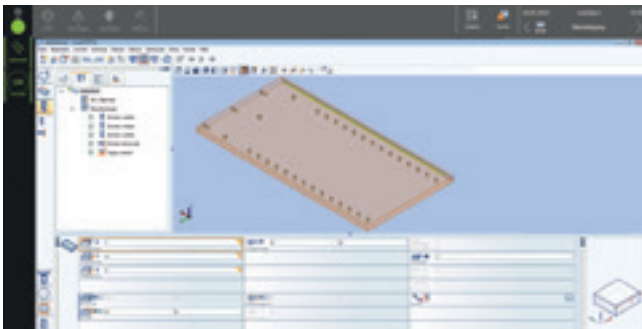

woodWOP

- Modern software based on Windows®
- Import of CAD files in DXF format
- More than 30,000 installations worldwide
- Worldwide largest forum for woodWOP



Production list software

- For management and creation of product lists for individual manufacturing



Slot assignment

- Simple control of main machine functions through soft keys
- Graphical loading



MMR Basic

- Machine Data Recording – collecting and evaluating machine states via time meter and event meter
- Display and logging of maintenance measures

Process optimization

CUT RITE, THE OPTIMIZATION SOFTWARE OF THE HOMAG, is used for cutting boards on sawing machines as well as nesting machines. The modular structure of the software allows users already controlling their sawing machine via Cut Rite to integrate the nesting module without problems. Plus, customer processes can be made even more efficient by woodCAD|CAM and residual parts management.

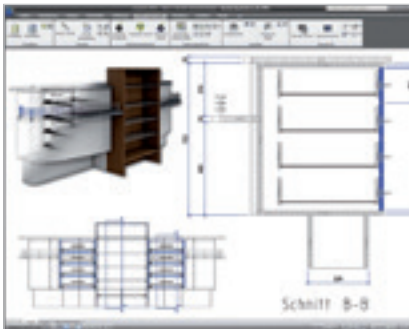

woodCAD|CAM

- Parametric design in 3D
- Seamless data flow in operation
- Bill of materials, cutting to size and cost estimation
- CNC data for HOMAG Group machines
- Bar code generation
- Photorealism for sales negotiations



Residual parts management | Basic

- Labels for residual parts from Cut Rite
- Manual management

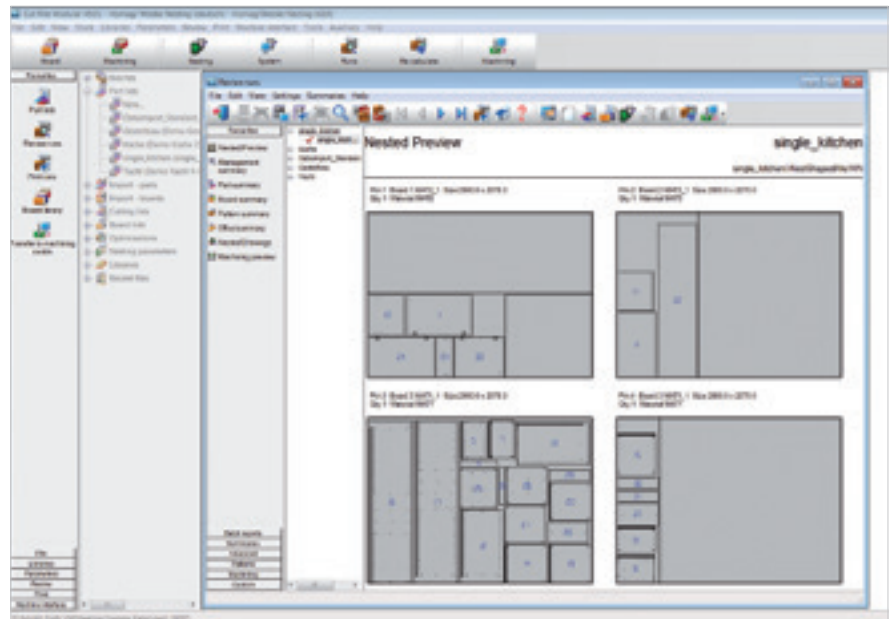

Optimization software: woodNest Basic and Cut Rite Nesting

- Optimization and generation of cutting plans for rectangular and free-formed workpieces (woodNest Basic: manually | Cut Rite: automatically)
- Functions with Cut Rite:
 - Import of parts lists, e.g. from Excel, or direct import of woodWOP programs
 - Additional milling strategies “bars”, “common line” and “stay down”
 - Includes material management, parts sorting by material type, and label printing in the office
 - Manual editing of cutting plans



Residual parts management | Advanced

- Automatic management within the storage database
- Manual positioning in automatic mode
- Labels for residual parts can be produced on the machine itself

Residual parts management | Professional

- Automatic residual parts handling for nesting concepts in conjunction with storage solutions from HOMAG Automation
- Only in combination with residual parts management | Advanced

Easy to get. And easy to use.

tapio is the open wood industry ecosystem

This means that everyone involved in the wood industry can participate.
Because together with our business partners, we develop digital solutions for everyone.



Just have a try:

Free use of the MachineBoard app! Just register under tapio and „connect“ the machine www.tapio.one. The complimentary usage is limited in time.

Apps that make working life easier

tapio

Partner

DataSave

- Protects machine and configuration expertise
- Faster service for machine breakdowns
- Saves time when restarting production
- Saves on maintenance costs
- Automatic backups of several machines

ServiceBoard

- Create service cases quickly and easily and send them to the correct service partner
- Live video diagnostics to solve service cases with image support
- Video reduces the language and distance barriers
- Also works without a machine connection to tapio (and is therefore ideal for older machines)

MachineBoard

- Push notifications
- Machine data and status can be viewed from anywhere in real time
- Lists of errors, warnings, maintenance tasks and actions
- Displays the remaining time until the next intervention by the machine operator



Free demo for all tapio apps, no registration required. Simply download and test.

Currently available in the EU and Switzerland.

(Due to the fast pace of the IT-landscape, the compatibility to the tapio platform is warranted for five years).

Technical data

Our machines are equipped with everything needed for safe and effective operation.

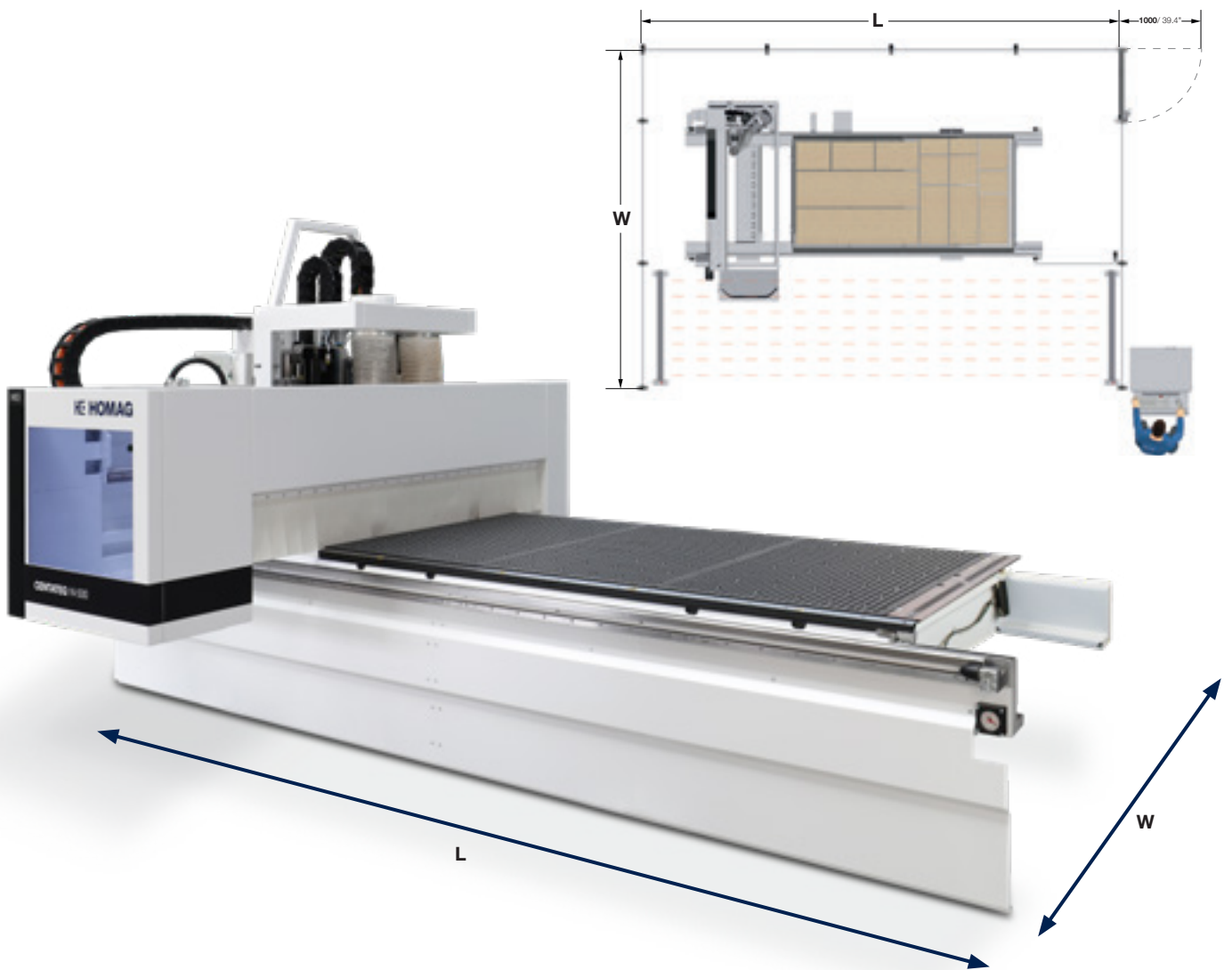

Vector speed X/Y - Z-axis	m/min	96 - 25
Compressed air connection	inch	R ½
Compressed air required	bar	7
Dust extraction port	mm	Ø 200*
Dust extraction volume	m³/h	min. 3.170*
Electrical power – total connection load	kW	27,5*

*Basic machine

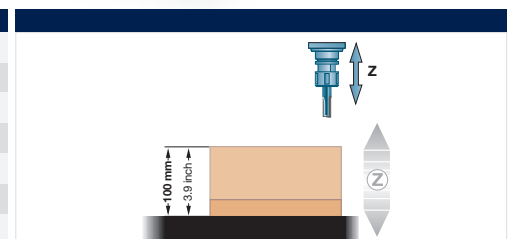

Working field	X	Y	Z
4 × 8 ft	2.520 / 99.2	1.250 / 49.2	100 / 3.9
5 × 10 ft	3.100 / 122.0	1.550 / 61.0	100 / 3.9
5 × 12 ft	3.700 / 145.7	1.550 / 61.0	100 / 3.9
6 × 12 ft	3.700 / 145.7	1.850 / 72.8	100 / 3.9
7 × 10 ft	3.100 / 122.0	2.250 / 88.6	100 / 3.9
7 × 14 ft	4.300 / 169.3	2.250 / 88.6	100 / 3.9

mm/inch

Travel range	Drilling gear	Routing unit
All table sizes	4-sided formatting possible	215 / 8.5
		245 / 13.7

mm/inch

Floor space incl. safety area**	L	W	
Manual concepts			
Basic machine	4 × 8 ft	6.480 / 255.1	4.350 / 171.3
	5 × 12 ft	7.630 / 300.4	4.550 / 179.1
	6 × 12 ft	7.630 / 300.4	4.990 / 196.5
	7 × 10 ft	7.030 / 276.7	6.150 / 242.1
	7 × 14 ft	8.230 / 324.0	6.150 / 242.1
Nesting concept outfeed	4 × 8 ft	7.870 / 309.8	4.350 / 171.3
	5 × 12 ft	9.996 / 393.5	4.550 / 179.1
	6 × 12 ft	10.002 / 393.8	4.990 / 196.5
	7 × 10 ft	9.400 / 370.1	6.150 / 242.1
	7 × 14 ft	11.610 / 457.1	6.150 / 242.1
Automatic concepts			
Nesting concept 1	4 × 8 ft	8.220 / 323.6	5.150 / 202.8
	5 × 12 ft	10.400 / 409.5	5.440 / 214.2
	6 × 12 ft	10.400 / 409.5	5.840 / 229.9
	7 × 10 ft	9.750 / 383.9	6.150 / 242.1
	7 × 14 ft	11.960 / 470.9	6.150 / 242.1
Nesting concept 1R	4 × 8 ft	11.770 / 463.4	5.150 / 202.8
	5 × 12 ft	14.600 / 574.8	5.440 / 214.2
	6 × 12 ft	14.600 / 574.8	5.840 / 229.9
	7 × 10 ft	13.380 / 526.8	6.150 / 242.1
	7 × 14 ft	17.800 / 700.8	6.150 / 242.1
Nesting concept 2	4 × 8 ft	10.470 / 412.2	5.150 / 202.8
	5 × 12 ft	13.950 / 549.2	5.440 / 214.2
	6 × 12 ft	13.950 / 549.2	5.840 / 229.9
	7 × 10 ft	12.720 / 500.8	6.150 / 242.1
	7 × 14 ft	16.100 / 633.9	6.150 / 242.1
Nesting concept 3	4 × 8 ft	10.850 / 427.2	5.150 / 202.8
	5 × 12 ft	14.300 / 563.0	5.440 / 214.2
	6 × 12 ft	14.300 / 563.0	5.840 / 229.9
	7 × 10 ft	13.470 / 530.3	6.150 / 242.1
	7 × 14 ft	16.260 / 640.2	6.150 / 242.1
Nesting concept 3R	4 × 8 ft	12.400 / 488.2	5.150 / 202.8
	5 × 12 ft	15.600 / 614.2	5.440 / 214.2
	6 × 12 ft	15.600 / 614.2	5.840 / 229.9
	7 × 10 ft	14.670 / 577.6	6.150 / 242.1
	7 × 14 ft	18.200 / 716.5	6.150 / 242.1

mm/inch

** Dimensions for table sizes 5 × 10 ft and 6 × 10 ft on request



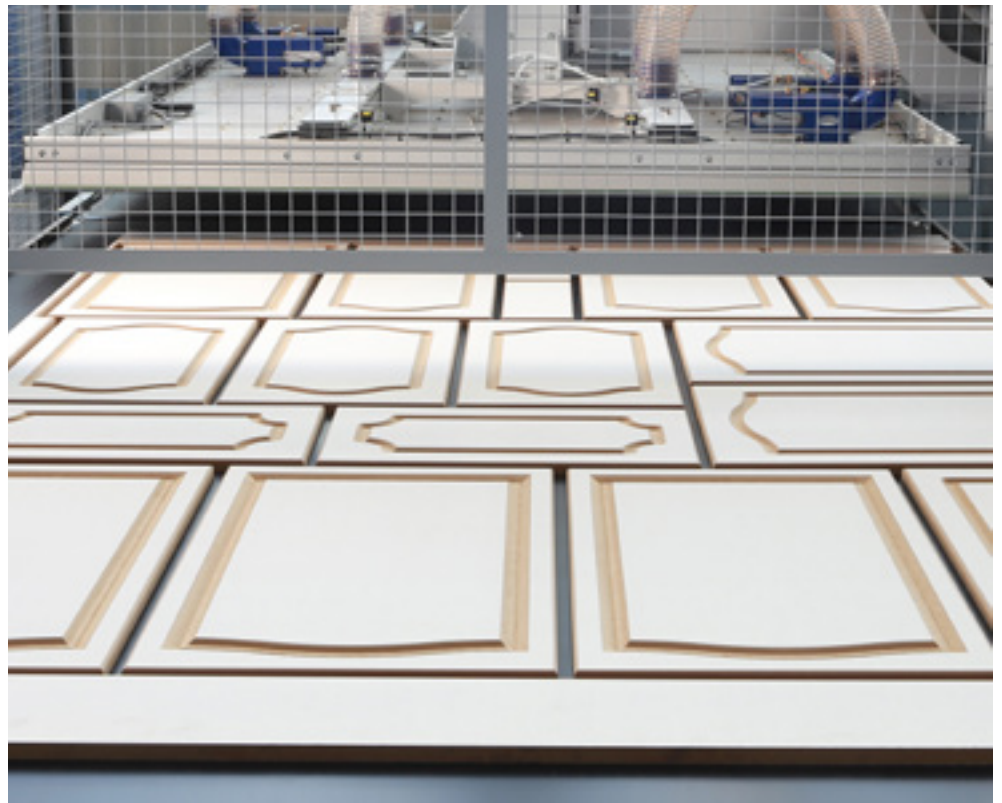

Improve your material utilization
with nesting!

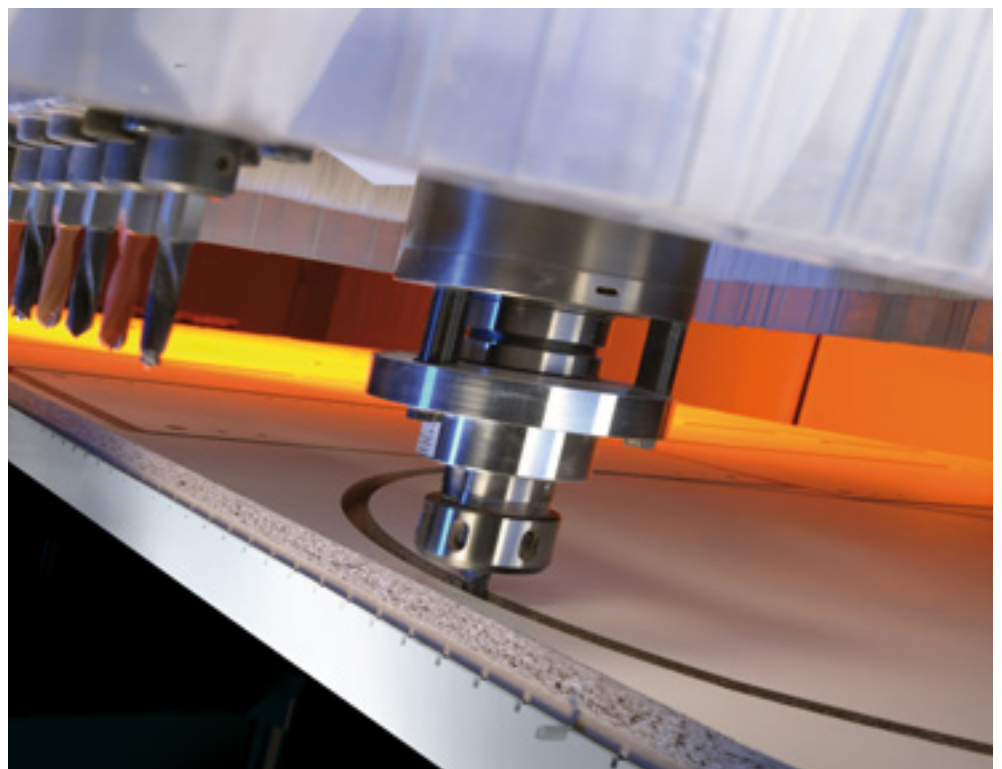

HC LIFE CYCLE SERVICES

Optimal service and individual consultations are included in the purchase of our machines. We support you with service innovations and products which are especially tailored to your requirements. With short response times and fast

customer solutions we guarantee consistently high availability and economical production – over the entire life cycle of your machine.



REMOTE SERVICE

- Hotline support via remote diagnosis by our trained experts regarding control, mechanics and process technology. Thus, more than 90% less on-site service required and consequently a faster solution for you!
- The ServiceBoard App helps to solve tasks in a fast, simple and concrete way. This is achieved by mobile live video diagnosis, automatic sending of service requests or the online spare parts catalog eParts.



SPARE PARTS SERVICE

- High spare parts availability and fast delivery.
- Ensuring quality by predefined spare parts and wear parts kits, comprising original spare parts.
- Identify and inquire for spare parts online under www.eParts.de 24/7, or buy even faster and more comfortably in the new HOMAG Webshop eCommerce.



MODERNIZATION

- Keep your machinery up to date and increase your productivity as well as your product quality, This is how you can meet tomorrow's requirements today!
- We support you with upgrades, modernization as well as individual consultancy and developments.



DIGITAL SERVICES

- ISN (intelliServiceNet) – The new remote service solution of the future! Fast restart of production because the remote service employee has extensive access to relevant physical data.
- intelliAdvice App – provides help for self-help. The preventive solutions proposed in the new App are the combination of our experiences and existing machine data.



SOFTWARE

- Telephone support and consultancy through software support.
- Digitalization of your spare parts via 3D scanning saves time and money compared to new programming.
- Subsequent networking of your machinery with intelligent software solutions ranging from construction to production.



FIELD SERVICE

- Increased machine availability and product quality by certified service staff.
- Regular checks through maintenance / inspection guarantee the highest quality of your products.
- We offer you the highest availability of technicians in order to reduce downtimes in case of unpredictable troubles.



For you more than...

1,350

service employees worldwide

90%

less on-site service thanks to successful remote diagnosis

5,000

customer training sessions per / year

150,000

machines, all electronically documented in 28 different languages – in eParts

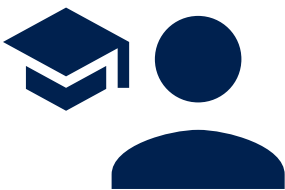

TRAINING

- Thanks to training perfectly suited to your requirements, your machine operators can optimally operate and maintain the HOMAG machines.
- The training also include customer-specific training documents with exercises proven in practice.
- Online training and webinars. Learn without traveling, meet your trainer in the digital classroom.

HOMAG Group AG

info@homag.com

www.homag.com



YOUR SOLUTION